

Cotton Waste Machinery



SPECIAL
COIL
TS
1583
.W58
W37
1919

LIBRARY



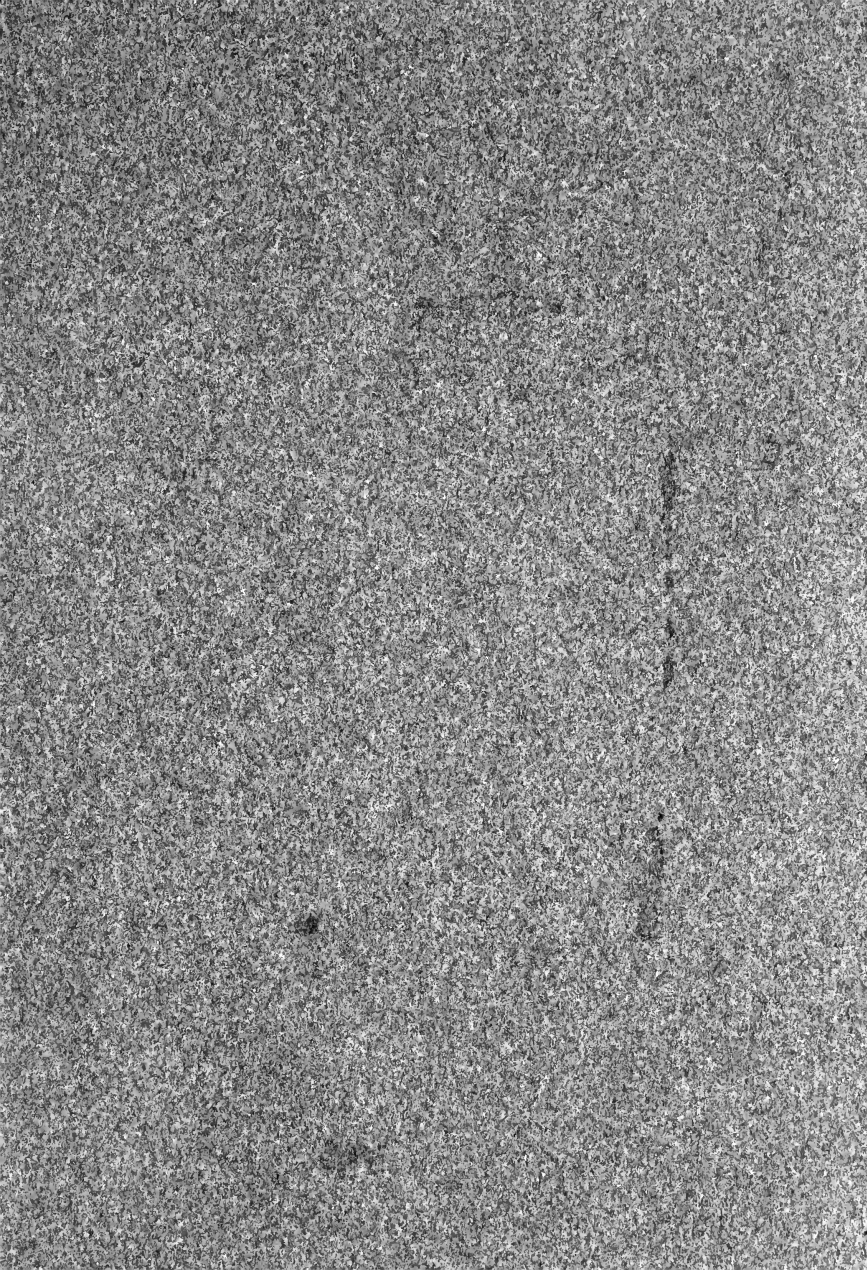



WHITIN
COTTON WASTE MACHINERY

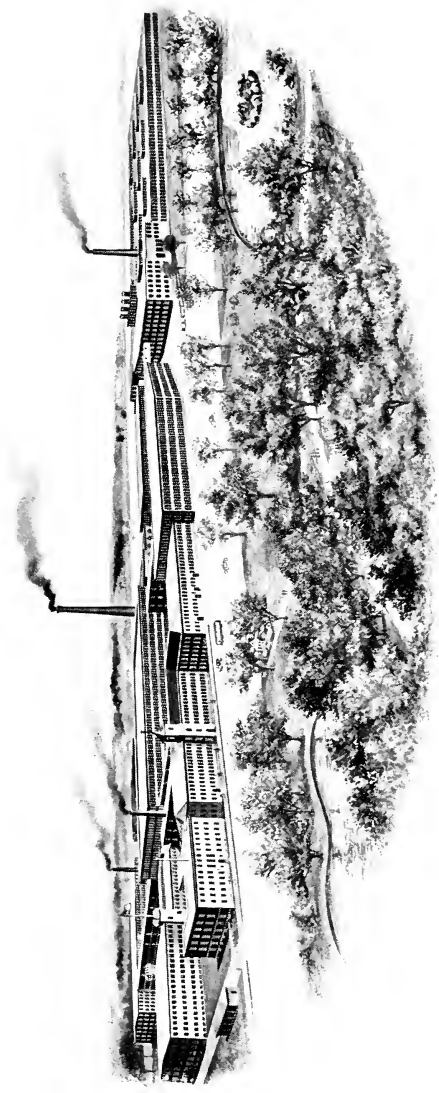

Whitin Machine Works, 1919

1919

ILLUSTRATED
AND DESCRIPTIVE CATALOG

of

WHITIN MACHINE WORKS

WHITINSVILLE, MASS., U. S. A.

SOUTHERN OFFICE : CHARLOTTE, N. C.

Printed by
PERRY & ELLIOTT CO.
Lynn, Mass.

1477



7
1 9

INTRODUCTORY

In these times of keen competition and strict attention to business details, no textile manufacturer can afford to neglect the question of waste, whether it be in the direction of reducing its amount, or in treating it so that it may be converted into marketable goods at a profit.

To meet the requirements of the trade for a line of machinery for reclaiming waste products, during the last decade we have developed and installed in many mills, machines that have proven themselves well adapted for such work. These machines are the direct result of specialization and concentration with one object in view, namely, the best that it is possible to make. A careful study has been made of the requirements to be met and our efforts have resulted in the production of the complete line of Waste Handling Machinery described in this catalogue.

Owing to changes that may have been made in the details of our machines since the issue of this catalogue, we cannot assume any responsibility for the dimensions and floor plans given in the catalogue unless verified by our Engineering Department. Up-to-date floor plans should be obtained from us before planning for the installation of our machines.

WHITIN MACHINE WORKS.

GENERAL
DIVISION OF CONTENTS

Systems of Working Cotton Waste . . .	Page 9
Preparation of Stock	“ 13
Roving and Spinners' Waste	“ 79
The Coiler System	“ 57
The Condenser System	“ 27

INDEX

	Page
CARD GRINDERS	85
COILER SYSTEM	57
Breaker Card	60
Derby Doubler	63
Ring Spinning Frame	71
Ring Twisting Frame	75
Revolving Flat Card	65
Slubber	68
CONDENSER SYSTEM	27
Breaker Full Roller Card	30
Finisher Full Roller Card.	33
Four-Bank Tape Condenser	39
One-Bank, Single Ring Doffer Condenser	44
Waste Spinning Frame	51
Two-Bank, Double Ring Doffer Condenser	42
Two-Card Set	37
Wool Spinning Frame	53
Scotch Feed	35
HANDS OF MACHINES	86

(Continued on next page)

INDEX — Continued

	Page
PREPARATION OF STOCK	13
Automatic Feed	26
Bale Breaker	15
Breaker Lapper	20
Finisher Lapper	22
Willow	18
REPAIRS	86
ROVING AND SPINNERS' WASTE	79
Roving Waste Card	82
SHIPPING DIRECTIONS	86
STOCK TO BE USED	12
SYSTEMS OF WORKING WASTE	9

SYSTEMS OF WORKING

COTTON WASTE

There have been many systems devised for the profitable working of waste, most of which have failed to give satisfactory results and have consequently been abandoned. Two systems, however, are in common use, namely, the Condenser System and the Coiler System, each of which have their adherents and we are prepared to furnish the necessary machines required by either system. Both systems make use of substantially the same machines for the preparation of the stock, but differ in the mechanisms at the delivery of the finisher card.

The Condenser System is particularly adapted for making soft, full, even yarns 1's to 10's, from soft waste, including picker droppings, card fly, cylinder and flat strips, comber noils, clearer laps, sweepings, oily waste, etc. The system has several variations to answer different conditions, ordinarily a set of two cards of the full roller type, a breaker and a finisher, is all that is necessary for the usual run of work, but a three or four card set can be used to advantage in producing a better quality of yarn. The feeding of the breaker card may be by a lap from the picker, or by an automatic feed. The cards may be connected in a number of ways, the most common being a cross feed, although, if desired, the finisher card may be fed by laps made on a Derby Doubler from sliver produced by the breaker card.

There are various means for taking the roving from the finisher card. The most important are the ring doffer condenser and the tape condenser. The former is preferred for producing good quality medium counts, whereas the latter is particularly adapted for use on all grades of waste for all counts at a low cost of

production. The spools of roving taken from the condenser may be spun on either of two separate types of continuous ring spinning frames which we have developed to meet the various demands of waste spinning.

The Coiler System is based on the customary process used in the average cotton mill, and is recommended when broken up hard waste is to be spun into 3's to 10's yarns in which strength is required rather than evenness. The system may be either a single or double carding process. In single carding a revolving flat card equipped with either a single coiler or a double coiler front is used, and the regular arrangement of spinning machines with short drafts and small delivery rolls is employed. In double carding, either a revolving flat card or preferably a full roller card is used as a breaker, and a full roller card or preferably a revolving flat card as a finisher. The finisher card is equipped with either a two, four or six-coiler front and the resulting slivers are then drawn through the rolls of a slubber and thence through the delivery rolls of an ordinary type of cotton ring spinning frame. On the finer counts, say 8's to 10's, two processes of roving are recommended.

In addition to the above-mentioned systems, we have devoted considerable attention to the reclamation of roving, spinner's or other soft wastes which have previously been subjected to twist. It is common practice among mills reclaiming waste of this kind to put it through a willow which beats it and tears it open, producing at the same time more or less broken fibres, constituting waste of an inferior grade, which is then mixed in small proportions with raw cotton and passed through the usual picking, carding, drawing and roving machines. In passing through these machines a shrinkage of from twelve to thirty-three per cent in weight is made, according to the number and nature of the workings, besides, the production owing to this drastic treatment, suffers an impairment of its value sufficient to reduce it to the next lower market grade of staple.

Most of the loss due to deterioration in quality and also in weight, above mentioned, are eliminated by making use of our Reclaiming Roving Waste Process, full description of which appears on page 80.

STOCK TO BE USED

It is very important that the various kinds of stock for spinning certain classes of yarn should be used in such proportions as to give a mix that will spin well. This, of course, can be best determined in each case by the carder, but it should be borne in mind that it will not pay to cheapen the mix to a degree that will cause the work to run badly or necessitate too much extra twist. Poor running work and excessive twist mean a loss of production, which will more than counterbalance any saving in the cost of stock obtained by the use of too low a grade of waste. The successful waste plant must get the maximum production from its machinery, and this can be obtained only by using a grade of stock suitable for the yarn to be produced. On very low grades of waste, a solution of oil and soap will sometimes help in getting the best results.



Bale Breaker

BALE BREAKER

This Machine is designed for the purpose of opening the stock from the bale. Where any great amount of stock is to be handled, the machine may be located in the warehouse, and as the stock passes from the machine, it may be distributed or exhausted to the bins in the cleaning and mixing department.

The Production of this machine is from 15,000 to 20,000 lbs. in 10 hours, and it delivers the stock to the next process opened in the best possible condition.

Speed of main shaft 450 r. p. m. Size of pulleys 12" x 2½".

Horse Power consumption is from 4 to 5 horse power.

Belting Required:

Pin apron belt 9' 3" of 3" belting,

Feed and Delivery apron belt 17' 0" of 2½" belting.

Extras:

Fans and Exhauster system,

Traveling aprons and Conveyor system.

Floor Space: 13' 8" x 5' 10½".

Weights:

Domestic:

Net, 4500 pounds,
Gross, 4600 pounds.

Export:

Gross, 6000 pounds,
Cubic feet, 200.

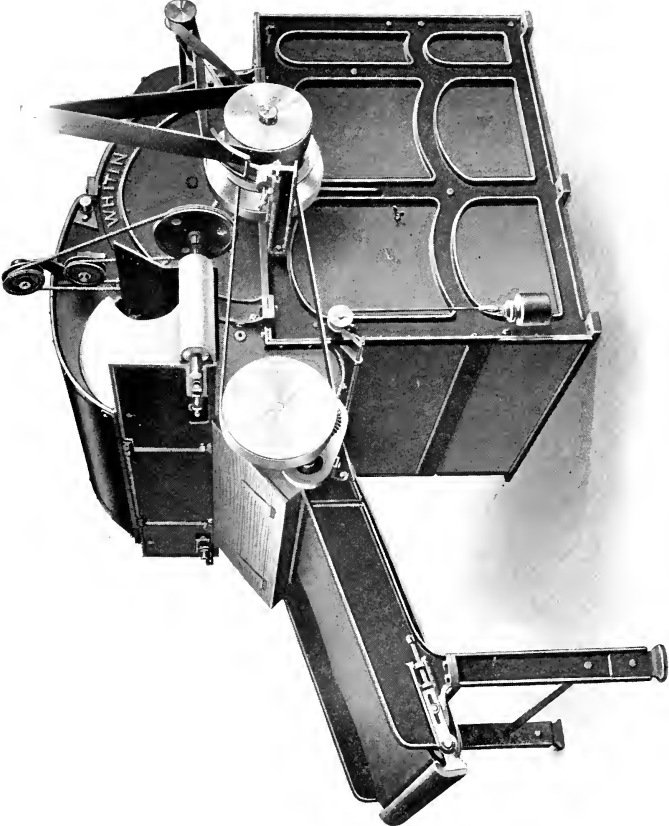

Willow with Hand Feed

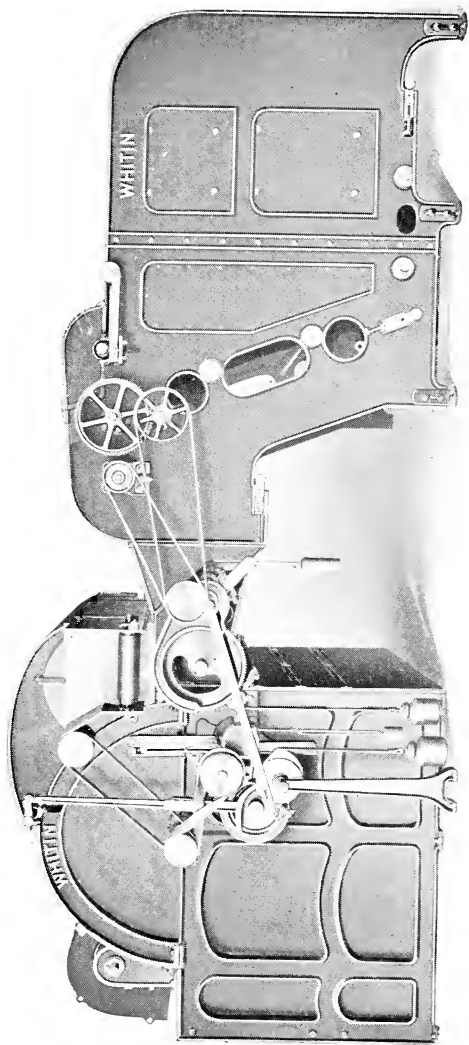

Willow and Automatic Feeder

WILLOW

This Machine is used for opening and cleaning any character of stock, and is equipped with a fan for down draft, exhausting the dust from the stock to the dust chamber of the Picking Department. It can be adjusted to willow the stock, more or less, as it may require. It can be made nearly automatic in its operation by cutting away the floor beneath the machine and allowing the dust to drop through onto an apron, which will carry it to the dumps; and the discharge of the clean stock can also be transferred by apron or exhauster system to bins. This machine is built with either hand feed or automatic feed.

The Production is 1500 to 5000 pounds per day of 10 hours.

Horse Power consumption is about 7 horse power.

Speed of cylinder 320 r. p. m. Size of pulleys 16" x 4".

Belting Required:

Feed apron belt 11' 0" of 2 $\frac{3}{4}$ " belting,
Fan belt 9' 9 $\frac{1}{2}$ " of 2" belting,
Regulator belt 4' 10" of 2" belting,
Roll belt 6' 4" of 1 $\frac{1}{2}$ " belting,
Delivery apron band 15' 0" x $\frac{5}{8}$ " diameter belting.

Extras Required:

Fans and pipes for exhauster system,
Traveling aprons and conveyor system.

Floor Space:

12' 0" x 7' 10" Hand Feed,
16' 10" x 7' 10" Automatic Feed.

Weights:

With Hand Feed:

Domestic:

Net, 5500 pounds,
Gross, 6800 pounds.

Export:

Gross, 7500 pounds,
Cubic feet, 300.

With Automatic Feed:

Domestic:

Net, 8500 pounds,
Gross, 9000 pounds.

Export:

Gross, 10,000 pounds,
Cubic feet, 350.

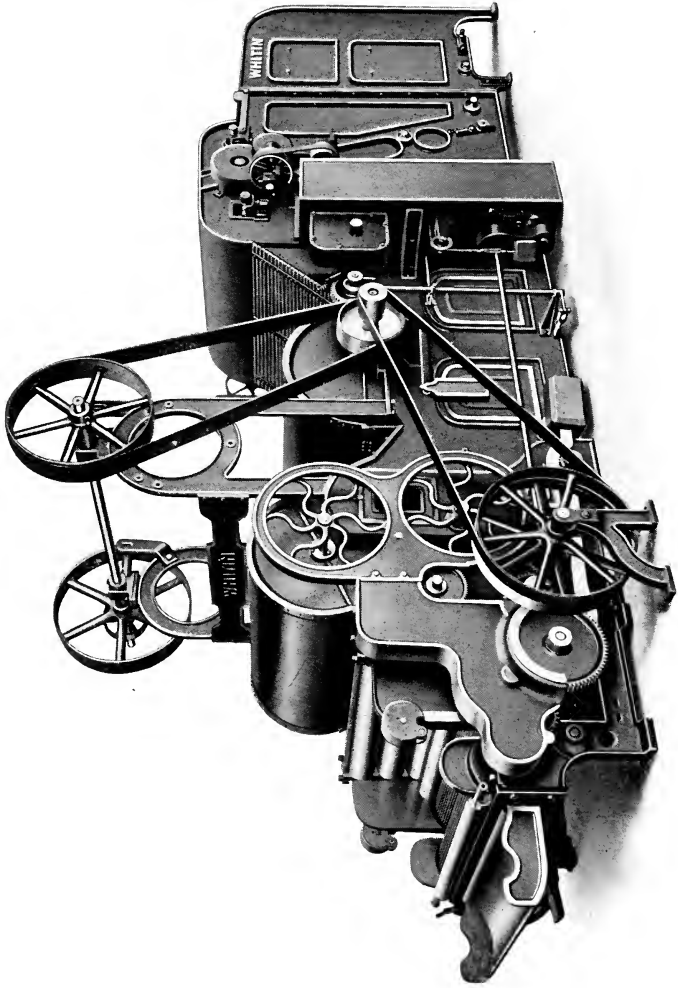

One Beater Breaker Lapper, with Automatic Feed and Evener

BREAKER LAPPER

This Machine is designed for the purpose of converting the raw stock into a lap. The machine illustrated is equipped with an Automatic Feed, Evener and one Beater. Preferably we recommend this machine to be built with two Beaters—the first of the Buckley Type—the second a Carding Beater.

The Production is 1800 pounds to 3200 pounds per day of 10 hours for one beater; 3500 for two beaters.

The Horse Power consumed is from 4 to 8 horse power, according to the number of beaters.

Speed of driving shaft 435 r. p. m. Size of pulleys 16" x 4 $\frac{1}{4}$."

Belting Required:

Fan belt 7' 11" of 2 $\frac{1}{2}$ " belting,
Beater belt 17' 5" of 4" belting,
Calender roll driving belt 12' 7" of 2 $\frac{1}{2}$ " belting,
Cone belt 6' 9" of 1" belting,
Doffer belt 10' 11" of 2 $\frac{1}{2}$ " belting,
Pin apron belt 5' 10" of 2 $\frac{1}{2}$ " belting.

Extras Required:

Lap Rods,
Automatic Feed,
Extra Beater Section,
Buckley Opener Section,
Steel Trunk Section,
Split Lap Preventers,
Adjustable Grid Bars.

Floor Space:

One Beater Machine 16' 0" long by 6' 8" wide,
Two Beater Machine 22' 0" long by 6' 8" wide.

Weights without Feeder:

Domestic:	Export:
Net, 8000 pounds,	Gross, 12000 pounds,
Gross, 8500 pounds.	Cubic feet, 200.

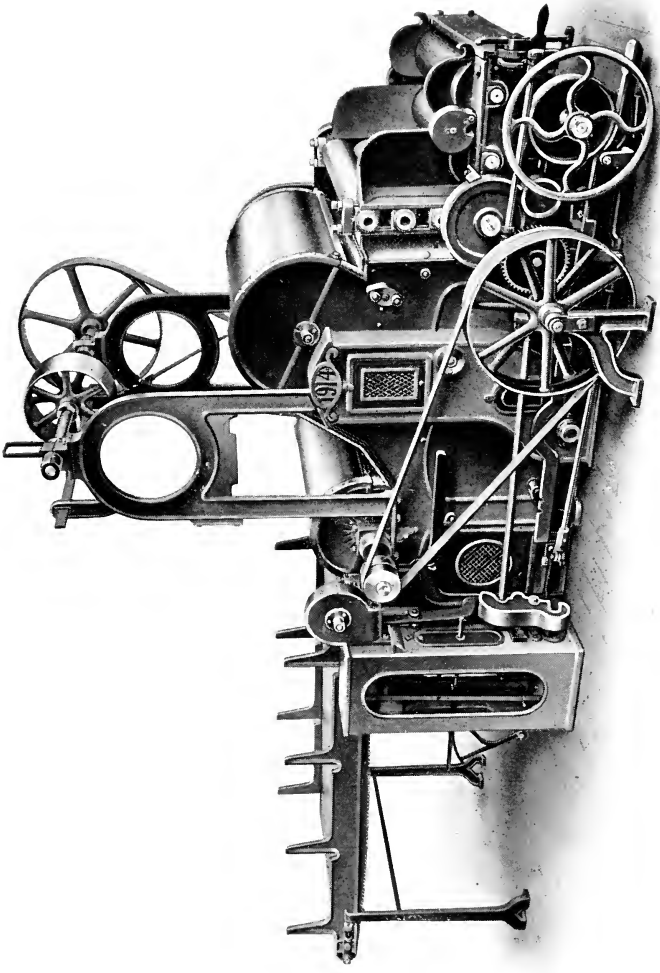

Finisher or Intermediate Lapper

FINISHER LAPPER

This Machine is used for second and third processes in picking, where, on the better classes of yarn, it is necessary to clean the stock a little better. The machine is equipped with an arrangement for doubling four laps at the back, and also an evener motion. It is used to form laps for the Breaker Cards, using the breaker picker laps on the back when used as an Intermediate and Intermediate laps when used as a Finisher.

The Production is 1500 to 3000 pounds per day of 10 hours.

Horse Power consumed about 4.

Speed of driving shaft 435 r. p. m. Size of pulleys 16" x 4 $\frac{1}{4}$ ".

Belting Required:

Cone belt 6' 9" of 1" belting,
Beater belt 14' 8" of 4" belting,
Calender roll driving belt 12' 7" of 2 $\frac{1}{2}$ " belting,
Fan belt 7' 11" of 2 $\frac{1}{2}$ " belting.

Extras:

Adjustable Grid Bars,
Lap Rods.

Floor Space: 16' 0" x 6' 8".

Weights:

Domestic:

Net, 6000 pounds,
Gross, 6200 pounds.

Export:

Gross, 8000 pounds,
Cubic feet, 150.

SPECIFICATIONS FOR PICKING MACHINERY

How many Machines?

What Machine?

Inside width of Machines?

To what are Automatic Feeders to be connected?

Length and Width of Conducting Trunk?

Length and Diameter of Conducting Pipe?

Width of Lap?

Weight of Lap per yard at back?

Weight of Lap per yard to be made?

Number of Beaters?

Style of Beaters?

Diameter of Beaters?

Revolutions per minute of Beaters?

Revolutions per minute of Main Shaft?

Are Machines to be Motor Drive or Belt Drive?

Diameter and Face of Driving Pulleys?

Is Evener Motion Wanted?

Production per day of 10 hours?

Length of Cotton to be used?

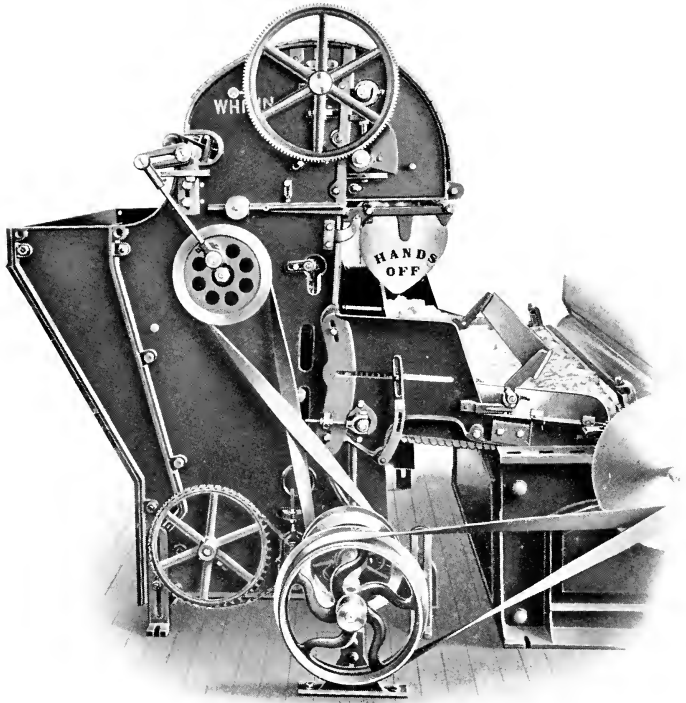

Automatic Feed
(Driving Side)

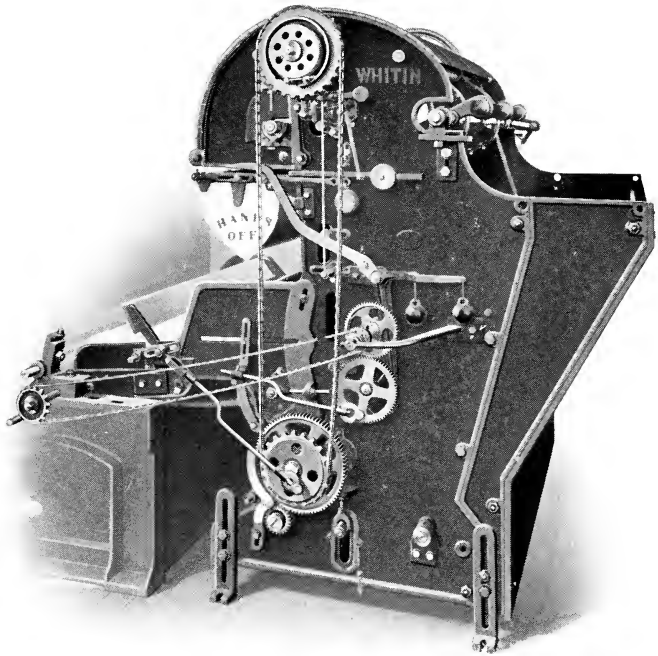

Automatic Feed
(Scale Side)

AUTOMATIC FEED

This Machine is used for feeding the stock to the breaker card, when pickers are not used, and it is recommended for the lower grades of stock, as it does not injure it, and gives as even a feed to the card as can be obtained, provided the machine is properly adjusted.

Size of pulleys 14" x 2 $\frac{3}{4}$ ".

Horse Power: $\frac{1}{4}$ horse power.

Belting Required:

Cone belt 8' 4 $\frac{1}{2}$ " of 2 $\frac{1}{2}$ " belting,

Doffer apron belt 9' 4 $\frac{1}{2}$ " of 1 $\frac{1}{2}$ " belting.

Extras:

Scott's Compensator,

Feed Roll.

Floor Space:

For 40" Card 5' 6" x 4' 6",

We build these for 40", 45", 48" and 51" Cards.

Weights:

Domestic:

Net, 1100 pounds,

Gross, 1200 pounds.

Export:

Gross, 2165 pounds,

Cubic feet, 100.

CONDENSER SYSTEM

for

COTTON WASTE, ETC.

The Condenser System of spinning waste yarns, a modification of the woolen system, has been greatly improved and developed during recent years. As compared with other methods of handling waste, it has many points to commend it, chief among which is its adaptability for various kinds of low grade waste. It is generally used for making coarse counts, and produces a full, even, lofty yarn. Because very little draft or twist is applied to the roving after leaving the cards, it is possible to spin fairly good yarns by this system from the lowest grades of waste, and from waste in which long and short fibres are mixed. This latter class of waste cannot be successfully handled by any other system. The condenser system admits of many variations in the manner of preparing the cotton for the cards, of connecting the cards, and of taking the roving from the finisher. We have a full line of this machinery to meet almost any condition. In this catalog we give detailed descriptions only of the types most in use, and will be glad to take up the matter of special equipment with those who do not find here exactly what they require.

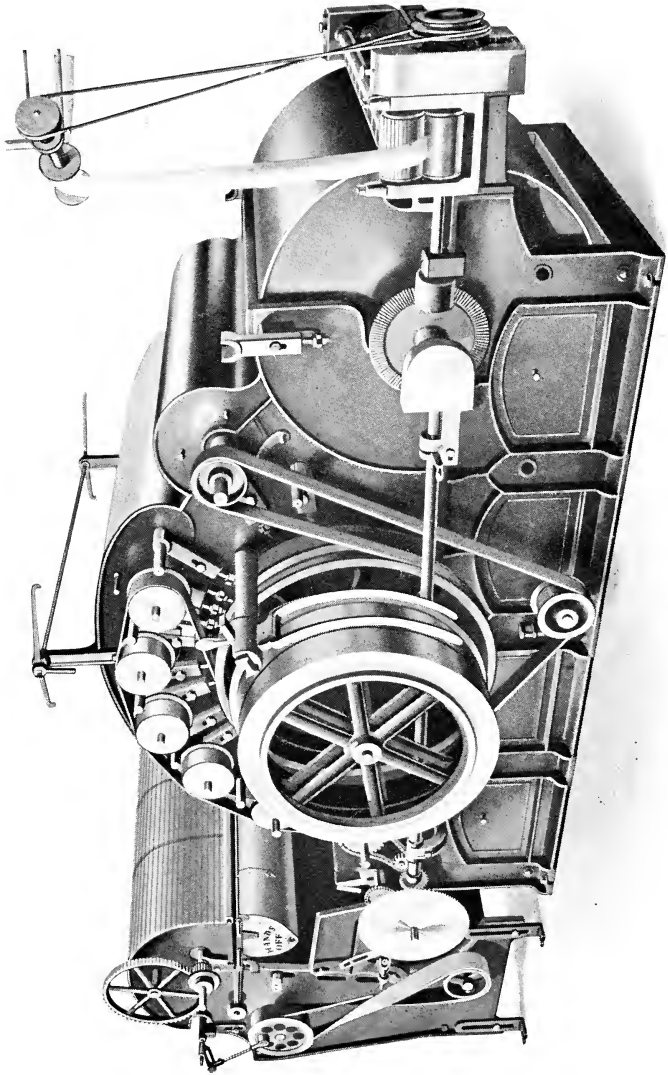

Breaker Card, with Automatic Feed

BREAKER FULL ROLLER CARD

The Cards used for the condenser system are of the full roller type, with 50" diameter cylinder and 30" or 36" diameter doffer, furnished in widths of 40", 45", 48", 51" and 61". The cylinders, perfectly balanced and ground to a true surface, run in removable bronze bushings set in heavy pedestals so designed as to prevent any overflow of oil from getting on the clothing of the cylinder.

The entire framework is substantial. The workers and strippers are of cast iron, balanced and ground to true surfaces. All shafts are of steel, and the fast-running shafts are case-hardened, insuring long life and perfect settings. All parts of the card are capable of easy and accurate adjustment.

All parts of the card are so inclosed that drafts are avoided, and no waste can accumulate within the frame except what is taken out under the screens. These screens are also special in their construction and arrangement, and are of easy adjustment.

The Breaker Cards are built for either lap or automatic feed; with or without metallic breasts; always with a fancy. If a doubler is used between breaker and finisher cards, the breaker is equipped with a two, four or six-coiler front or with belt conveyor front and one coiler. When a cross-feed is used, the sliver is taken directly from the breaker card and laid either straight or diagonally across the back of the finisher.

Production: 200 to 400 pounds per day of 10 hours.

Speed of Cylinder: 100 to 165 r. p. m., depending on the class of stock used.

Size of Driving Pulleys: 20" x 3", 24" x 4", or 30" x 5".

Power: From 1½ h. p. to 3 h. p., depending on speed and production desired.

Clothing: Depending on class of work and grade of stock to be run. Counts of wire and foundations to suit.

Supplies: Roving Cans.

Extras: Supplied as ordered.

Automatic Feed,
Double Lap Back,
Metallic Breast,
Belt Shipper.

Floor Space: 48" card, 9' 1" long, 7' 7" wide.

Weights, 48" Card.

Domestic:

Gross, 9500 pounds,
Net, 8200 pounds.

Export:

Gross, 10000 pounds,
Cubic feet, 500.

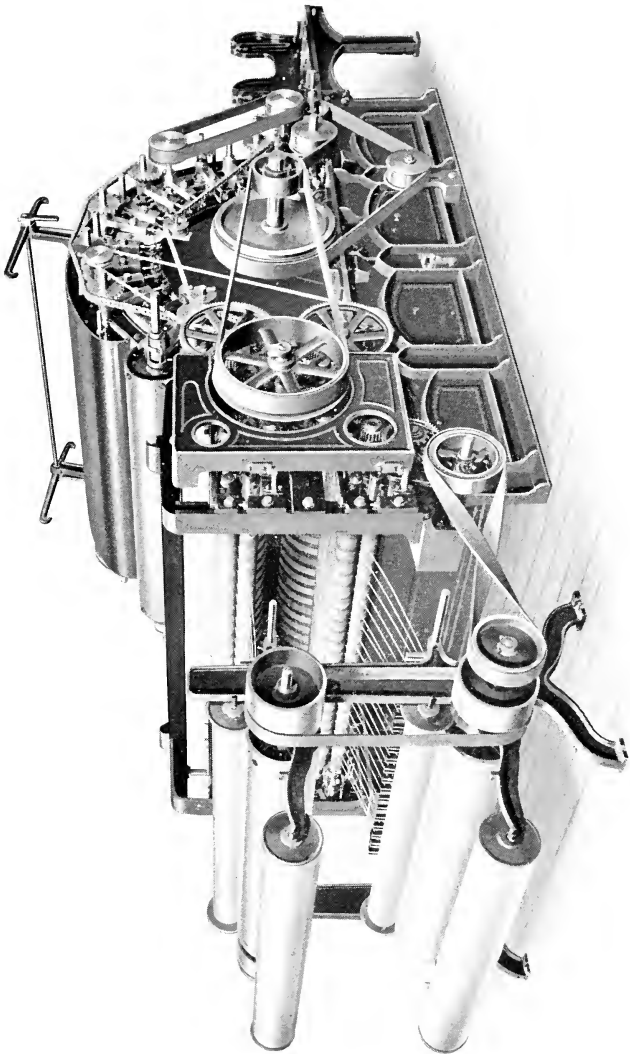

Finisher Full Roller Card, with Double Bank Condenser

FINISHER FULL ROLLER CARD

The Finisher Cards are of the full roller type, similar in construction to the breaker card with 50" Diameter Cylinder in widths of 40", 45", 48", 51" and 61". The arches and bearings are so constructed that very accurate settings can be made and retained. All rolls have shell ends. Metallic breasts can be applied to the finisher cards when desired, or when the class of stock requires them; and all finisher cards are equipped with a fancy roll. Where **Derby Doublers** are used, the finisher cards are built with either single or double lap backs, and the lap is taken directly from the lap head to the back of the finisher card. When the doubler is omitted, a cross-feed is used, the cards being connected either tandem or parallel. The finisher card is built with either a single or double doffer. With a single doffer, the roving is delivered to a single-bank condenser, or to a four-bank tape condenser. Where the double doffer is used, the roving is delivered to a double-bank condenser, or, under certain conditions, to a tape condenser. Each of these various methods of condensing and delivering the roving has its advantages, the style used depending on the conditions to be met.

Production: 175 to 300 pounds per day of 10 hours, depending on roving to be made and quality required.

Speed of Cylinder: 100 to 165 r. p. m., depending on stock to be carded.

Size of Driving Pulleys: Either 20" x 3", 24" x 4", or 30" x 5".

Power: 3 to 7 h. p., depending on style of machine.

Supplies: Jack Spools.

Extras:

Double Lap Back,
Cross Feed.

Extras:

Tape Condenser,
Single Bank Condenser,
Two Bank Condenser,
Metallic Breast.

Weights 48" Card:**Domestic:**

Net Weight, 8200 pounds,
Gross Weight, 9500 pounds.

Export:

Gross, 10000 pounds,
Cubic feet, 500.

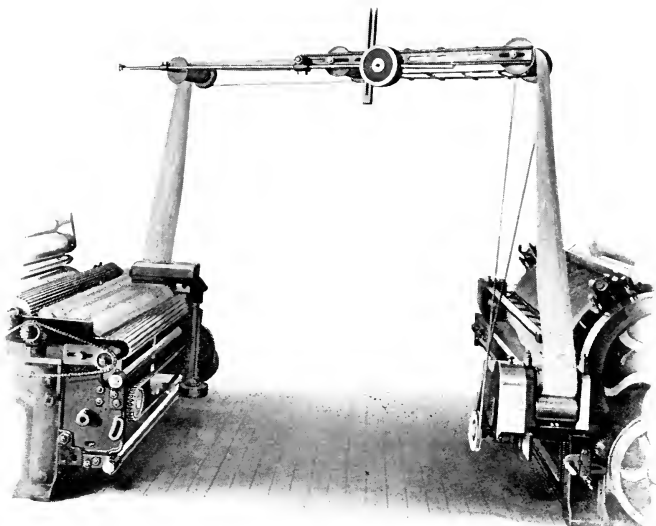

SCOTCH FEED

By this device the Finisher Card is automatically fed from the Breaker Card, and thus the necessity for Coilers and Doublers is obviated. For working a very low grade of stock the Scotch Feed gives superior results as compared with the Doubler system, as the cotton is delivered in a fleecy condition instead of being compressed into a lap.

The web of sliver from the doffer of the Breaker Card is compressed, by means of two calender rolls at the side of the doffer, into a sliver about five inches wide. This is then transported by means of a traveling overhead belt to a pair of rolls mounted in a carriage over the feed lattice of the Finisher Card. The carriage moving sideways across the card deposits the sliver in uniform layers upon the lattice.

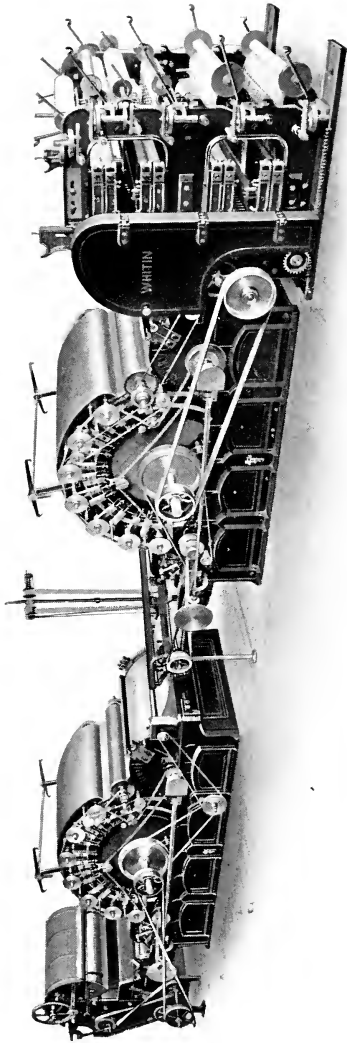

Two-Card Set

TWO-CARD SET

Carding of **Cotton Waste** by the condenser system is customarily done with **Two-Card Sets**, the cards being placed either tandem or side by side. In the set shown on the preceding page, the stock is fed to the breaker card by an automatic feeder which can be regulated to deliver the material evenly in any quantity desired. The breaker card is equipped with a metallic breast which helps break up any bunches and tends to save the card clothing. Also, it so opens up the stock that, instead of allowing it to be drawn in in bunches, it delivers the material in a fleecy, even web in which condition it is best prepared for the card proper to do its work, ensuring large productions and first quality of work. The web is taken from the doffer on a belt conveyer front, through side calender rolls and then by way of an overhead lattice apron to a Scotch feed at the back of the finisher card. A diagonal feed may be had if preferred, but the lattice used with the Scotch feed makes it feasible to use very short staple without the sliver breaking down. From the finisher card the web is carried to a four-bank **Tape Condenser** which separates and condenses it into from 80 to 96 good ends of roving, according to the class of work to be done. This type of condenser can make a much finer roving than the older types, with little variation in the size of the ends, and the spools of roving can be spun to comparatively fine numbers of waste yarn with very slight draft.

Both Breaker and Finisher Cards have a fancy roll, and all rolls have shell ends. The workers are chain-driven and the tops of the cards have substantial steel covers. The doffer comb motion which is run in oil, contained in an oil-tight comb-box, can be driven at high speed without heat, noise or undue vibration.

The Production of this set is from 175 to 300 pounds per day of 10 hours. For detailed specifications, see descriptions of individual cards on pages 30 and 33.

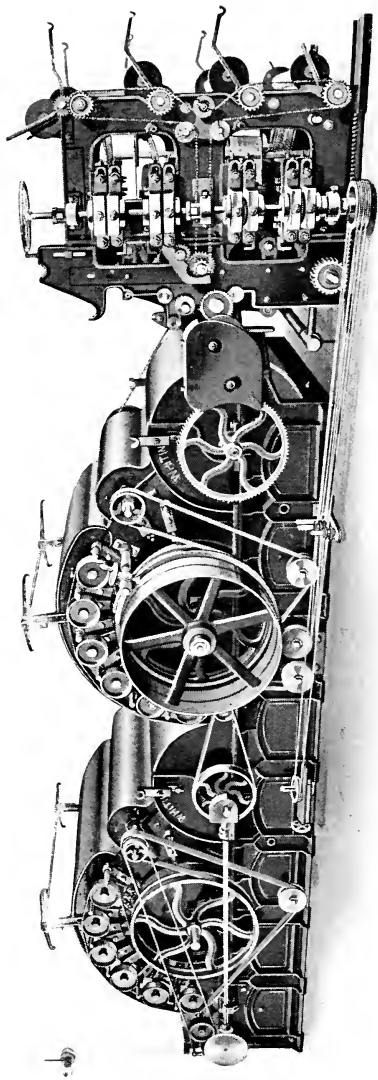

Intermediate and Finisher Cards, with Four-Bank Condenser

FOUR-BANK TAPE CONDENSER

The **Four-Bank Tape Condenser** is a modern and most successful machine for condensing cotton waste roving, especially if the roving is to be spun into comparatively fine yarn. With this condenser the web from the card doffer passes between two grooved rolls, which separate the web into strips of exactly equal width, very much in the same manner that a piece of sheet steel is sheared by cutting rolls. The grip is not positive enough, however, to cut any individual fibres. Running in the grooves of both top and bottom dividing rolls are leather tapes to which the narrow strips of cotton web adhere as soon as they are separated. These tapes carry the web to the condenser rolls, which detach the web from the tape and rub it into roving, making from 80 to 96 good ends.

The method of separating the web on this condenser gives a very even roving, with little tendency to variation. It is also possible to make an unusually light roving, since other methods of condensing require that the strip of web from the doffer be strong enough to sustain its own weight. For the same reason it is possible to run very **Short Staple** because light roving can be spun with very little draft into fairly fine numbers of yarn. In quantity of **Production**, too, this type of condenser has the advantage over the old types, and marks a distinct advance in the methods of handling low grade cotton waste.

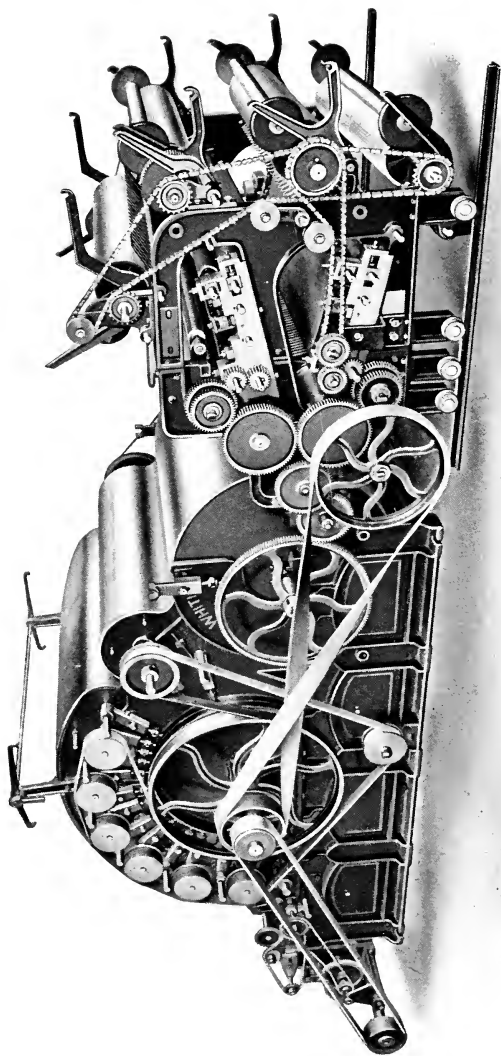

Finisher Card, with Model C Two-Bank Condenser

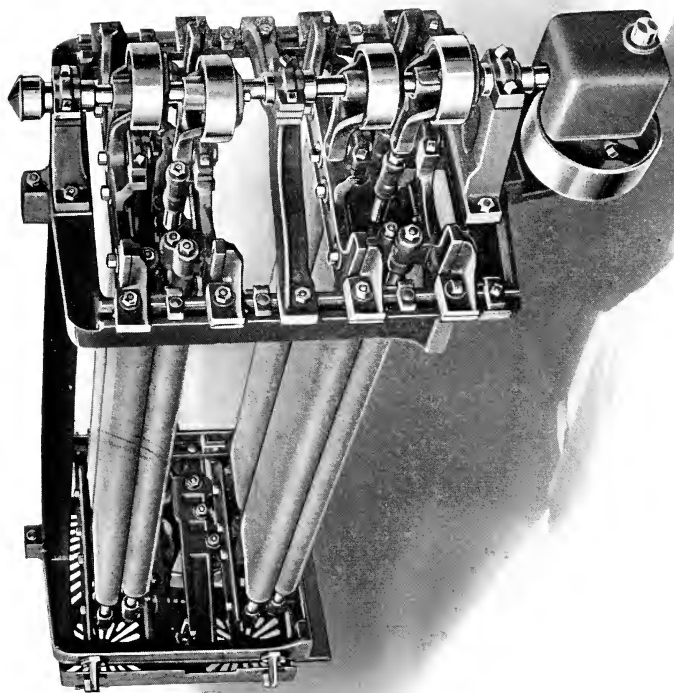

Two-Bank, Double Ring Doffer Condenser

TWO-BANK DOUBLE-RING DOFFER CONDENSER

This type of condenser, illustrated on preceding page, has been used in this country for many years in connection with the woolen system for low grade cotton. The cotton is taken from two doffers clothed with rings of card clothing separated from each other by narrow strips of leather. These leather rings serve to divide the web into strips of equal width, which are kept separate and carried forward by a large grooved roll to be rubbed into roving by the condenser. The number of ends to be taken off can be determined by the width of the clothing rings put on the doffers, 24 to 30 good ends from each doffer or 48 to 60 ends to a 48" card being a fair average. This is a standard type of machine and is preferred by many manufacturers for producing medium numbers.

MODEL C CONDENSER

The illustration on page 40 shows a type of Two-Bank Condenser that meets the approval of many carders on account of its simplicity and ease of operation.

One-Bank, Single Ring Doffer Condenser



ONE-BANK, SINGLE-RING DOFFER CONDENSER

This Condenser is similar in operation to the double bank condenser, except that the regular 30" single doffer is used in place of two small doffers on the double bank condenser. Also, the stock is carried by grooved rollers from the doffer to the condenser aprons. This machine is used very widely, particularly for a production of medium count yarns, and not over 42 ends to the 48" width card is recommended. This machine particularly commends itself to coarse work, where the number of ends taken from the condenser are limited. It is a very popular arrangement, and in some cases the roving spool is taken directly from the condenser and placed in a special creel on a slubber, for the purpose of producing coarse yarns, either with or without draft.

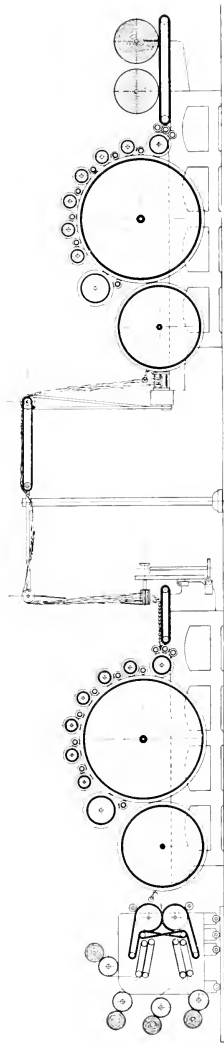

TWO CYLINDER SET

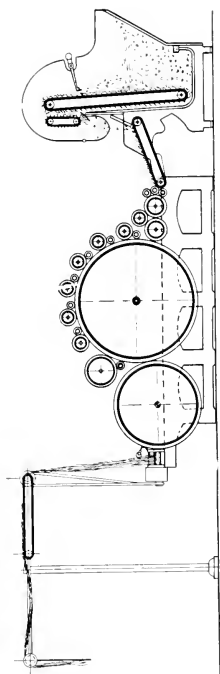
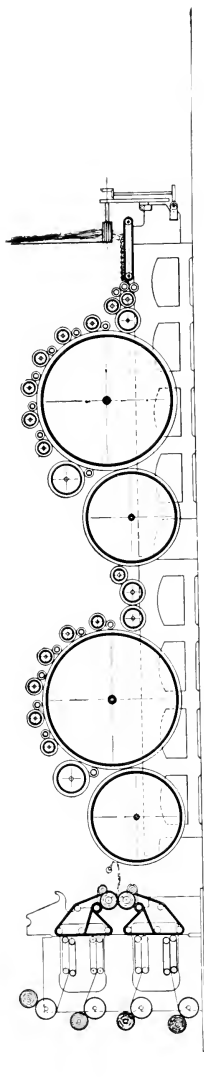

THREE CYLINDER SET

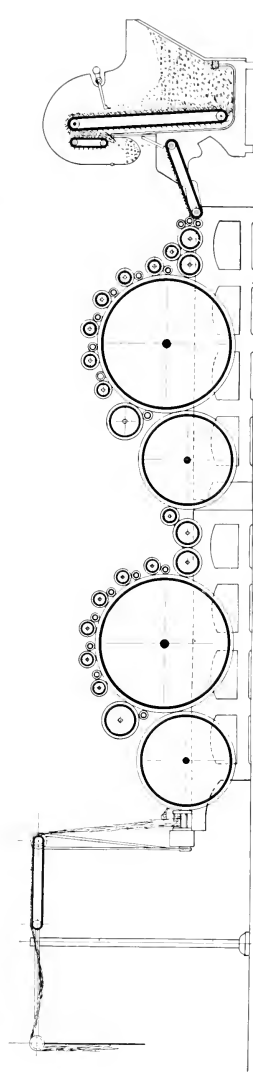
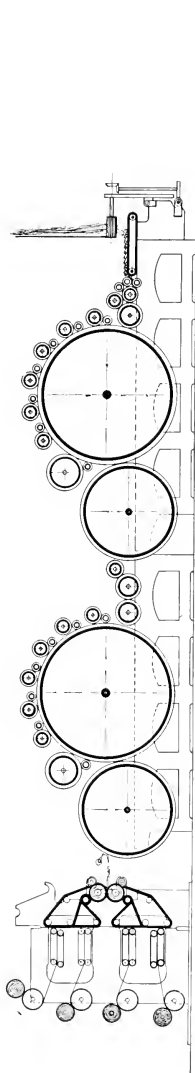

FOUR CYLINDER SET

SPECIFICATIONS FOR FULL ROLLER CARDS

- How many Full Roller Cards?
- What width Card?
- How many of each hand?
- Belt Drive, or Motor Drive?
- If Belt Drive, Driving Pulleys are 24" x 3".
- If Motor Drive, state teeth and pitch of Receiving Gear?
- Are Cards to be furnished in Sets?
- If in Sets, how many in each Set?
- How are Cards to be connected?
- What kind of Stock will you use?
- Automatic Feed, or Picker Lap?
- Single or Double Lap Rolls?
- If Double Lap Rolls are wanted, what kind?
- Are Metallic Breasts to be applied?
- Are Auxiliary Lickerins to be applied?
- What kind of Front is wanted?
- If Coilers, how many?
- What is diameter of Coiler Cans?
- What is weight of Sliver or Roving?
- Draft or Draft Gears?
- Cross Feed or Derby Doubler?
- How many Doffers on Finisher Card?
- If Condensers, how many ends?
- If Condensers, what kind?
- Production per day of 10 hours?
- Is Roll Grinder wanted?
- How many Long Grinder Rolls wanted?
- How many Traverse Grinder Rolls wanted?

If you have any preference as to Clothing, state foundation, counts and number of points.

Breaker Card	{	Cylinder? Doffers? Workers? Strippers? Lickerin? Fancy?	}	Intermediate Card	{	Cylinder? Doffers? Workers? Strippers? Lickerin? Fancy?	}
-----------------	---	------------------------------------------------------------------------	---	----------------------	---	------------------------------------------------------------------------	---

Finisher Card	{	Cylinder? Doffers? Workers? Strippers? Lickerin? Fancy?	}	Card Connecting Rolls	{	First Roll? Second Roll?	}
------------------	---	------------------------------------------------------------------------	---	--------------------------	---	-----------------------------	---

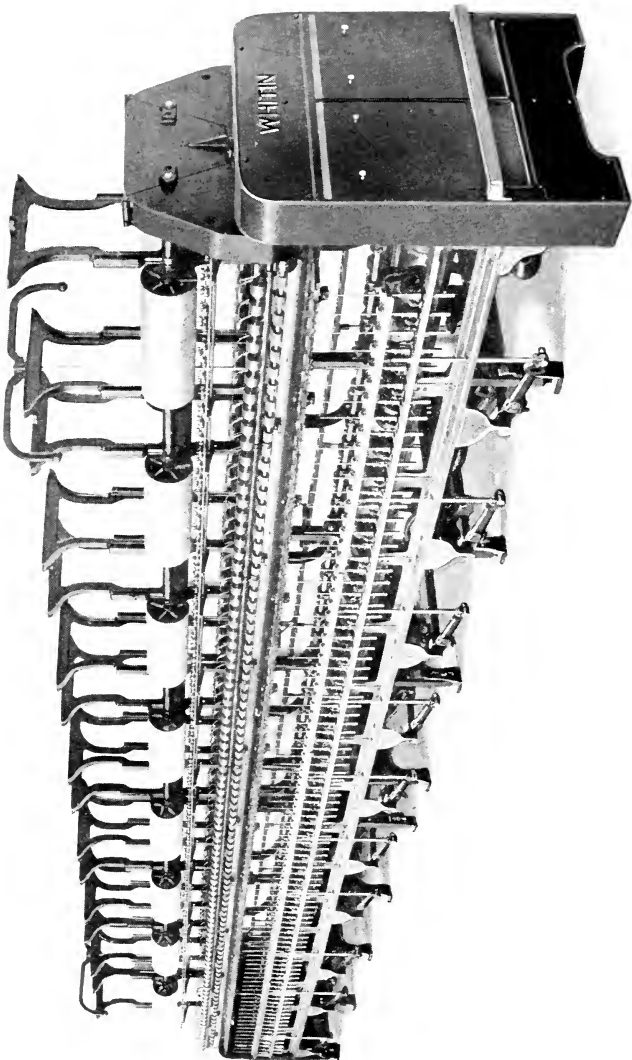

Jack-Spool Frame

JACK-SPOOL WASTE SPINNING FRAME

This Machine is designed particularly for the spinning of coarse yarns with no draft from oily cotton, card waste, comber noils, shoddies, sweepings, linters or other low grades of stock. It is particularly suitable for spinning such yarns as filling yarns for blankets and flannelettes, hosiery yarns, backing yarns for carpets, woolen goods and shoddies. As compared with Mule Spinning, these yarns can be spun on this frame with a considerable saving in labor, investment and horse power. The roving is delivered direct to this spinning frame from the jack-spools made on the Card Condensers. The spools are placed in the creel of the frame and are supported by drums whose rotation carries the roving forward to the delivery rolls with little or no draft. The yarn is then spun by means of spinning rings and travelers in the same way as on an ordinary cotton ring spinning frame. **Practically No Draft** is imparted to the yarn in this process, and the result is a lofty and soft thread. The twist can, however, be increased when necessary for the making of backing or hard, strong yarns. The framework is designed to embody strength and rigidity with neatness of detail and accuracy of workmanship.

Weights per Foot:

Domestic:	Export:
Gross, 250 pounds,	Gross, 318 pounds,
Net, 220 pounds.	Cubic feet, 7.5.

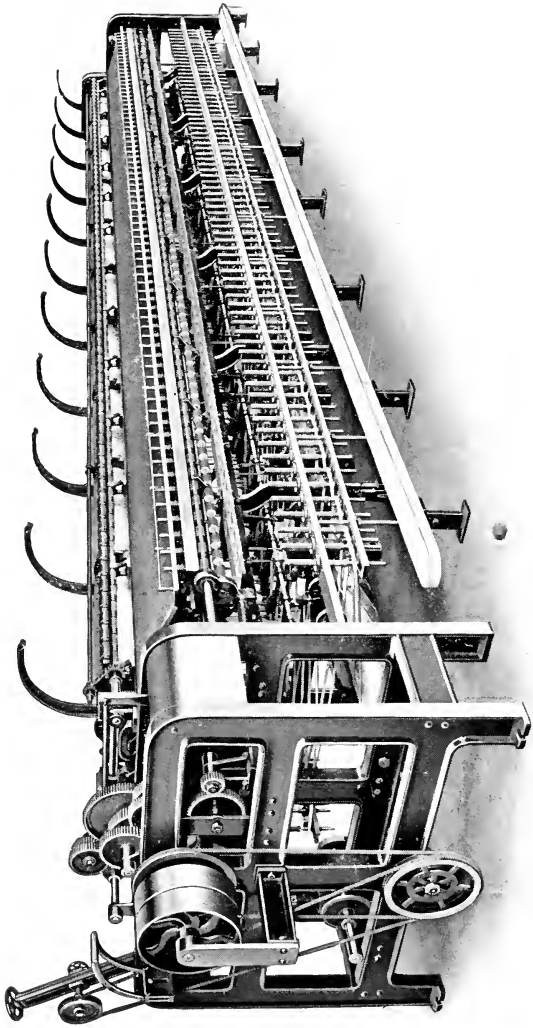

Wool Spinning Frame

WOOL SPINNING FRAME

(Pease Patent)

For many years it has been the aim of numerous inventors to devise a machine for the **Continuous Spinning of Wool**, with the object in view of overcoming the serious disadvantages of small production, excessive floor space, and large labor costs, existing at present in the spinning of wool on mules.

After several years of unremitting study and experiment, at great expense, the efforts in this direction have been crowned with success in the invention of a **Continuous Ring Spinning Frame for Wool**, under the patents of which we are now manufacturing our so-styled "**Wool Spinning Frame.**"

This frame has **Two Principal Features** of usefulness. While primarily it was designed for the spinning of woolen yarn, that is, rovings made on the woolen condenser card, it has been found to be equally applicable to rovings made on the same system from cotton or **Cotton Waste**, producing soft, full threads of low counts, with the least possible amount of twist, suitable for cotton blankets, robes, bedspreads, hosiery and knit goods, and, in fact, almost everything for which coarse counts of cotton yarn are used.

It is a well-established fact that the underlying principles of the mule are essential to give a sound thread from rovings made on a condenser card. All condenser roving is delivered to the spinning frame with a greater or less amount of uneven places in it. This consists of what is known as "twits" and bunches; and as the fibres from the condenser system are not laid parallel, the evening up of this unevenness can be more successfully accomplished by the introduction of twist during the drawing process. The effect of this is that the twist takes hold of the smaller places first at the expense of the thicker, so to speak, thereby holding these finer places, while the larger, softer parts of the roving are drawn down to a uniform size. This method of drawing is known as the

mule system, or **Mule Method**. The principal feature of the Whittin Wool Spinning Frame is the adoption of the **Mule Method** in combination with the advantages of greatly increased production, less floor space and low labor costs of the ring system of spinning.

As will be seen by reference to the illustration of this frame, the roving spools from the condenser card are held between two parallel lines of drums, whose motion passes the roving to a pair of delivery rolls. It is then drawn over the deflector rod, through a twister tube, to the drawing rolls, and thence to the ring, and is wound on the bobbin in the usual way common to ring spinning.

In spinning yarns from **Cotton Waste** the draft between the delivery rolls and the drawing rolls is constant, and the process of drawing is materially aided by the twisting tube between the two sets of rolls, which imparts a false twist to the roving, and at the same time by means of two pegs on the top of the tube the roving is agitated during the drawing, which produces the same effect as is done by the slipping of the yarn off the spindle point in mule spinning.

Another Feature of this frame which enables yarns of soft twist to be spun is the traversing of the bolster rail, the ring rail being stationary, and consequently the traveler drag on the yarn is unvarying.

The Production depends upon the counts of yarn and class of material being spun. As compared with that of the mule it varies under different conditions from $1\frac{3}{4}$ to $3\frac{1}{2}$ times as much. The latter figure would apply to the spinning of fine warp yarns, and the former to the production of a very thick, soft twisted filling or knitting yarn.

The saving in **Floor Space**, as compared with the mule, is, of course, dependent upon the character of yarn spun. If it is a thick, soft yarn, the amount of space saved would not be more than 40%; but on fine counts, with a fair amount of twist (which all fine yarns necessarily have), the saving would reach as high as $\frac{2}{3}$ or $66\frac{2}{3}\%$. The actual over all dimensions of a 144-spindle frame, 4-inch gauge, would be 5 feet 10 inches wide by 28 feet 6 inches

long. On a basis of two and one-half times greater spindle capacity, there would be in this above-mentioned area an equivalent of 360 mule spindles.

Pulleys: 14-inch diameter by 3-inch face, run 450 revolutions per minute.

Horse Power: About 50 spindles per horse power.

Weights:

Domestic:

Gross, 350 pounds per foot,

Net, 270 pounds per foot.

Export:

Gross, 400 pounds per foot,

Cubic feet, 17.

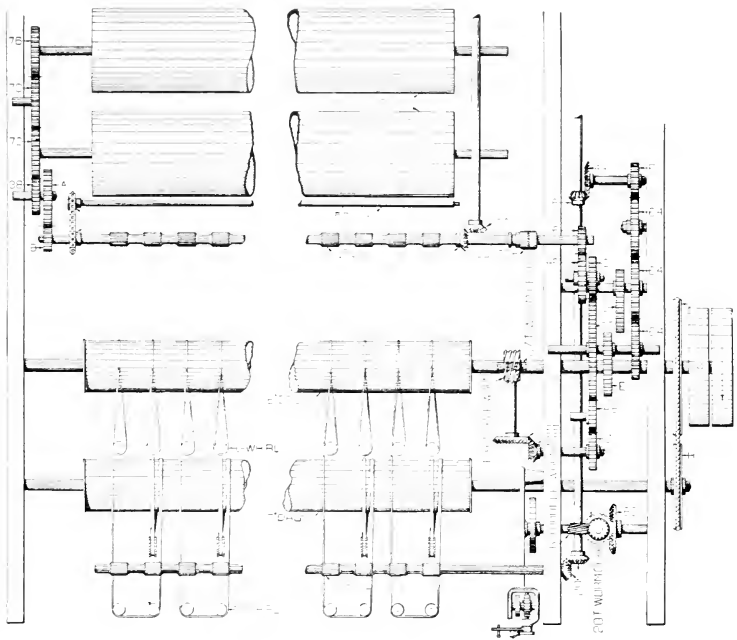

BEARING DIAGRAM of WOOLEN SPINNING FRAME.

DIAGRAM REFERENCES

- A = Change Gear 82, 83, 84 teeth.
- B = Change Gear, 22 to 28 teeth.
- C = Change Gear, 37 to 48 teeth.
- D = Elliptical Gear, 63 teeth.
- E = Elliptical Gear, 63 teeth.
- F = Change Gear, 24 to 40 teeth.
- G = Rope Pulley, 12" to 18" diameter.
- H = Rope Pulley, 9" to 14½" diameter.
- J = Change Gear, 18 to 40 teeth.
- K = Change Bevel Gear, 20, 25, 30, 35, 40 teeth.
- L = Twister Head Whirl—variable diameter.
- M = Spindle Whirl—variable diameter.

THE COILER SYSTEM

for

COTTON WASTE, ETC.

This System is well known in the manufacture of cotton yarns, having been used for many years with the regular machinery for producing low grade yarns from mixtures of waste and cotton, but manufacturers for some time have been trying to avoid the operation of mixing waste with their regular work on account of rejection of orders and general criticism from buyers, because of poor quality of the product. This has created a demand for the development of machinery with which they are familiar for the handling of different by-products without a mixture of cotton, and converting it into a marketable product, a system of machinery which would run sufficiently well to enable them to obtain maximum production at minimum labor cost. In comparison with other countries, the cost of the plant and the high cost of labor have been two very serious factors in this country in the development of this class of machinery. However, after considerable study, designing and many experimental tests, we have accomplished very satisfactory results, and now bring to the consideration of textile manufacturers our **Coiler System of Waste Machinery**, which consists of a Breaker Card, a Derby Doubler, a Finisher Card, a Slubber and a Ring Spinning Frame. The product of the Breaker Card, which may be a Full Roller or Revolving Flat type, is taken in cans to the back of the doubler, which prepares laps for the Finisher Card. This card may be of the **Revolving Flat Type** or Full Roller, as desired. It is equipped with or without metallic breast, fancy roll and a two, four or six-coiler front. The slivers from this card are either doubled on a drawing frame, or preferably taken directly to the back of the slubber. For finer numbers, where a better grade of stock is used, it may be necessary, in order to ac-

comply good results, to run the roving from the slubber through another roving process. The adoption of this system we are confident will produce gratifying results in productions and labor costs.

It is not possible to use so low a grade of stock as with the condenser system, because the yarn produced on that system is the result of separating and rubbing the stock into a small roving, without draft. The finisher card is peculiarly adapted for running stock of such a nature as to prohibit much drafting, the weight of the slivers rendering it possible to obtain a much finer yarn, from low grade stock, than has previously been practical.

The roving cans are regular in size, allowing minimum handling, and the labor thus saved enters materially into lowering the cost of production.

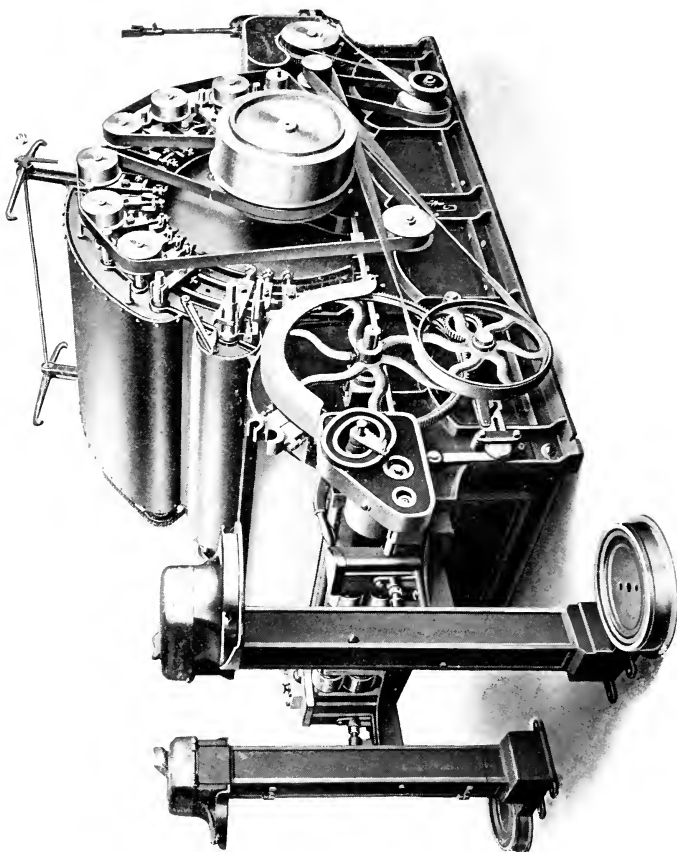

Full Roller Card, with Two Coilers

FULL ROLLER CARD

This machine is built in five widths, viz.: 40", 45", 48", 51" and 61". It has a 50" diameter cylinder and a 30" or 36" diameter doffer and may be fed, when used as a Breaker, with either a picker lap or from an automatic feed, and the product is delivered either into cans or a Scotch Feed. When used as a Finisher, it can be fed by laps from a Derby Doubler or by means of a Scotch Feed, and the product delivered to a coiler front of from one to six cans as ordered.

Pulleys: 20" x 3"; 24" x 4"; or 30" x 5".

Speed of cylinder: 100 to 165 r. p. m.

Production: 200 to 400 pounds per day of 10 hours.

Power: 1½ to 3 horse power.

Floor space: 48" card, 9' 1" long by 7' 7" wide.

Weights 48" card:

Domestic
Gross, 9500 pounds,
Net, 8200 pounds.

Export:
Gross, 10000 pounds,
Cubic feet, 500.

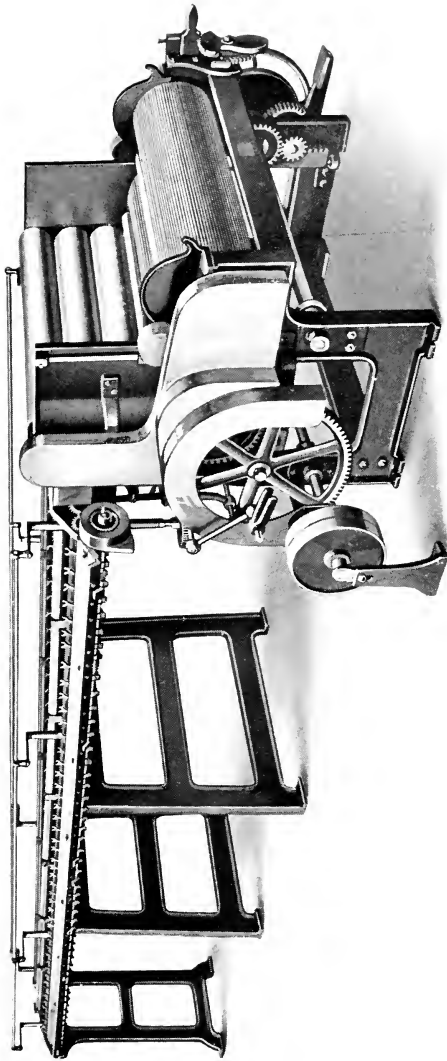

Derby Doubler

DERBY DOUBLER

This machine is used in the double carding system to take from 80 to 96 breaker card slivers and form them into a lap $46\frac{3}{4}$ inches wide for use at back of a 48-inch finisher card. The machine is provided with stop-motions which stop the machine when an end of sliver breaks at the back, and also when the lap attains its full diameter. All gearing is thoroughly guarded with covers, preventing injury to operatives.

Driving Pulleys: 12 inches in diameter by 2-inch face and run 250 revolutions per minute.

Production: 3000 pounds per day of 10 hours.

Power: One horse power.

Floor space: Including 96 12-inch cans, 20' 5" long by 10' 11" wide.

Weights:

Domestic:

Gross, 5000 pounds,
Net, 4500 pounds.

Export:

Gross, 6000 pounds,
Cubic feet, 200.

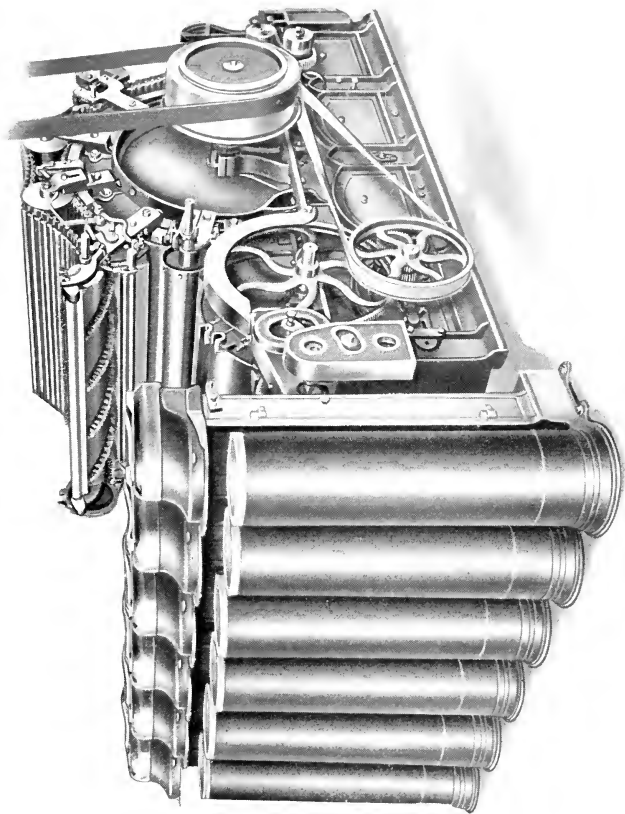

Revolving Flat Card

REVOLVING FLAT CARD

This machine is our standard 40-inch or 45-inch Revolving Flat Card. It is equipped with 110 flats, 50-inch diameter cylinder, 27-inch diameter doffer, and from one to six coilers.

Pulleys: 20 inches diameter by 3-inch face.

Speed of Cylinder: 165 r. p. m.

Production: 100 to 150 pounds per day of ten hours.

Power: 1.25 horse power consumed.

Floor space: 10' 6" by 5' 10 $\frac{1}{4}$ ".

Weights, 40" card

Domestic:

Net, 6200 pounds,
Shipping, 6700 pounds.

Export:

Gross, 8000 pounds,
Cubic feet, 325.

SPECIFICATIONS FOR REVOLVING FLAT CARDS

- How many **Revolving Flat Cards**?
- Width of Card?
- How many each hand?
- Driving Pulleys are 20" x 3".
- Are Belt Shippers to be furnished?
- Length of Cotton to be used?
- Are Fancies wanted?
- Weight of Lap per yard?
- Width of Lap?
- Number of Laps at back?
- Single or Double Lap Rolls?
- If Coilers are wanted, how many with each Card?
- Diameter of Coiler Can?
- Weight of Sliver per yard at Doffer?
- Draft?
- Production wanted per day of 10 hours?
- Diameter Lickerin Pulley driving Doffer?
- How many Long Grinder Rolls?
- How many Traverse Grinder Rolls?
- State preference, if any, as to number of points in Clothing?
- State preference if any, as to number of points in Cylinder?
- State preference, if any, as to number of points in Doffer?
- State preference, if any, as to number of points in Tops?
- State preference, if any, as to number of points in Fancy?

Note:—Cylinders of Revolving Flat Cards are 40" and 45" wide x 50" diameter. Belt from overhead. Metallic Lickerin $9\frac{1}{2}$ " diameter. Doffer 27" diameter. 110 Top Flats $1\frac{3}{8}$ " wide, $\frac{1}{16}$ " on wire. The regular size of Lickerin Pulley driving Doffer is $4\frac{1}{4}$ " diameter, and this size will be furnished unless otherwise specified.



Slubber

SLUBBER

This Machine takes the sliver from the cans delivered from card front and imparts sufficient draft and twist for the succeeding operation of the Spinning Frame.

The machine is built with special features for the purpose of handling **Low Grade Stock**. The front steel roll is 1" in diameter instead of the usual 1 $\frac{1}{4}$ ", which allows the rolls to be set closer together to accommodate the shorter fibre. To lessen the breakage of the sliver as it is drawn from the cans, an auxiliary lifting roll is provided at the back of the machine.

The machine may be fitted with either direct weighted or **Self Balanced Rails** as preferred. It is fitted, if desired, with case-hardened front steel rolls, shell front top rolls, self-oiling steps, and sheet steel gear casings. As will be noted in the illustration on the preceding page, the driving pulley arbor is supported by a yoke which insures freedom from vibration and ease of operation.

For Productions, etc., see our catalog of "Cotton Card-Room Machinery."

Weights per foot:

Domestic	Export
Gross 315 pounds,	Gross 384 pounds,
Net 280 pounds.	Cubic feet 8.5.

SPECIFICATIONS FOR SLUBBER

How many Machines?

What Process?

How many Spindles each?

Size of Bobbin?

What Space between Spindles?

Are Spindles to be our regular size? (See Note Below.)

Are Bobbin Gear Collars to be our regular size? (See Note Below.)

How many Right Hand?

How many Left Hand?

Hank Roving to be made?

Draft?

How many teeth in Draft Gears?

Diameter of Front Steel Roll?

What kind of Front Top-Rolls?

Twist per inch?

How many teeth in Twist Gears?

How many teeth in Traverse Gears?

How many teeth in Tension Gears?

Creel for what size Bobbin?

Size of Pulleys? Diameter and width of Face?

Belt from Above or Below?

Self-Balanced Rails?

Length of Cotton to be used?

Are Front Steel Rolls to be case-hardened?

Are Self-Oiling Steps to be furnished?

Note:—If these machines are **Not** to match machines built by the Whitin Machine Works or the Providence Machine Co., and are to match machines built by some other machinery builder, please send us sample Spindle, Bolster, Bobbin Gear and Bobbin.

We allow three change gears each for Draft, Twist, Tension and Traverse, also 5% spare Top-Rolls.

Machines will be painted **Black** unless otherwise specified.



Ring Spinning Frame, with Tape Driven Spindles

RING SPINNING FRAME

The spinning frame used on the coiler system has a number of special features to fit it particularly for this waste work. It has a special arrangement of bottom steel rolls and top-rolls so as to facilitate the setting of the frame for this class of work. This machine is built on a wide gauge, with large special rings and a long traverse. The illustration shows the frame equipped with the **Tape Drive Spindle**. It can be built either with the band or tape drive, as desired. The tape drive lends itself, perhaps, more appropriately to this class of work than the ordinary band drive. The tape drive frame shown has a specially designed geared end which facilitates all changes in the gearing, and accidents to operatives are avoided by the use of light steel panels, which completely enclose all working parts. The spindles used are the well-known Whitin Gravity Improved Type, and are capable of high speed, steady running, and are especially recommended as free from tendency to throw oil, thus ensuring clean work. Outside of being particularly adapted and arranged for waste work, the construction of the frame is similar to the frames that we build for ordinary cotton spinning. Particulars as to production, change gears, etc., can be found in our catalog, on "Cotton Yarn Machinery."

Weights per foot:

Domestic	Export
Gross 250 pounds,	Gross 318 pounds,
Net 220 pounds.	Cubic feet 7.5.

SPECIFICATIONS FOR RING SPINNING FRAMES

- How many **Ring Spinning Frames**?
- How many Spindles each?
- Kind and Size of Spindles?
- Diameter of Whirl?
- Are Spindles to be Band Drive or Tape Drive?
- Space between Spindles?
- Number of Spindles per Roll?
- Size and Flange of Rings?
- Cast Iron or Plate Holders?
- Size of Holders?
- Are Traveller Cleaners wanted?
- Warp, Filling or Combination Builder?
- If Combination Builder, state if it is to be set for Warp or Filling
- Draft?
- Twist per inch?
- State number of Yarn to be spun?
- Are Creels to be one or two story?
- Are Frames to spin from Single or Double Roving?
- State size of full Roving Bobbin?
- State full length of Skewer?
- Size of Driving Pulleys? Diameter and Width of Face?
- Belt from Above or Below?
- Are Driving Pulleys to be at Head or Foot End?
- Traverse?
- Are Frames to have Separators?
- Size of Separator Blades?
- Are Frames to be 36" or 39" wide?
- Kind of Saddles?
- Kind of Lever Screws?
- Kind of Guide Wires?
- How many teeth in Cylinder Gear, Jack Gear and Crown Gear?

Are Cylinders to be 7" or 8" diameter?
State distance required between Top of Bobbin and Guide Wire?
Are Frames to have Metallic Thread Board?
Are Frames to be shipped Knocked Down or On Feet?
Are Front Steel Rolls to be case-hardened?
Length of Cotton to be used?
Are Hank Clocks to be furnished?

Note:—**Band Drive** Frames will be belted at the **Head End** and **Tape Drive** Frames will be belted at the **Foot End** unless otherwise specified.

Frames are regularly furnished with **Short Boss, Solid Top Rolls**. Please send us **Two Sample Bobbins** such as you will use on these frames. We allow five per cent spare Top-Rolls extra and three sets Draft and Twist Gears.

EXTRAS.

Gauge, over $2\frac{3}{4}$ " for every quarter inch.
Where frames have 8 spindles per section of roll, for every 16 spindles under 208 spindles.
Where frames have 6 spindles per section of roll, for every 12 spindles under 204 spindles.
Large Gravity, or Heavy Type Spindle.
Centrifugal Clutch on Light Spindles—Standard or Medium.
Centrifugal Clutch on Large or Heavy Type Spindles.
Tape Drive.
Whitin Separators.
Dixon Adjustable Saddles.
Dixon Locking Saddles (not adjustable).
Whitin Patent Saddles.
Speakman Adjustable Lever Screws.
Whitin Patent Metallic Thread Board.
Case-hardened Bottom Rolls per line.
Shell Front Top-Rolls.
Self-Weighted Middle and Back Rolls.
Solid Nickered Roving Rods.
Hank Clocks.
Parts for applying Motor Drive.
Boxing for Knocked-down Shipment.
Cork Insert Pulleys.
Portable Sewing Machine with Stand.
Spindle Tape for Tape Drive Spinning.

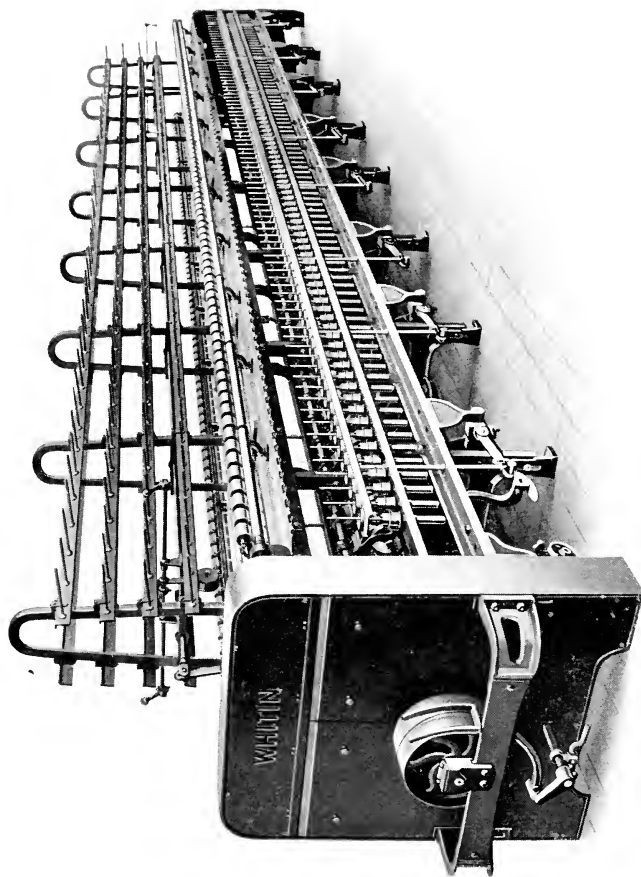

Ring Twisting Frame, with Tape Driven Spindles.

TWISTING FRAME

The illustration on the preceding page shows the latest development in our line of twisting frames with **Tape Driven Spindles**. The design embodies all the desirable features that our long experience with this class of machinery has demonstrated as necessary for a practical and economical working machine.

The frame may be built for either dry or wet twisting, as preferred, and of such number of spindles and gauge as best suits the requirements of the manufacturer.

The construction is similar to that of our spinning frame, excepting the ring and bolster rails are of a much heavier design.

The frame is equipped with the tape driven Whitin Gravity type of spindles, which ensures uniformity in twist, large production and economy in operation.

This machine is particularly well adapted for twisting from two to six-ply waste yarns.

For further particulars, such as floor spaces, productions, gear changes, etc., see our catalog on "Cotton Yarn Machinery."

Weights per foot:

Domestic

Gross 250 pounds,
Net 220 pounds.

Export

Gross 318 pounds,
Cubic feet 7.5.

SPECIFICATIONS FOR TWISTERS

How many **Twisters**?
Wet or Dry Twisting?
How many Spindles each?
Size of Spindles?
Diameter of Whirl?
Are Spindles to be Band Drive or Tape Drive?
Space between Spindles?
Size and Flange of Rings?
Band, Common, Single, Adjustable or Vertical Rings?
If Band Ring in Brass Plate Holder, state size of Holder?
Number of Yarn to be twisted?
How many Doublings into one?
How many Creel Spindles per Twister Spindle?
How many rails high are Creels to be made?
Size of Spool to be used on Creels?
Distance between Creel Rails?
Length of Creel Spindles overall?
Size of Driving Pulleys? Diameter and Width of Face?
Belt from Above or Below?
Are Driving Pulleys to be at Head or Foot End?
Are Belt Guards to be furnished?
Twist per inch?
How many Lines of Bottom Rolls?
Length of Traverse?
Straight, Filling, Warp or Combination Builder?
If Combination Builder, set for what wind?
Will you use Long Wind with Taper Top? Regular or Reverse?
Are Twisters to have Metallic Thread board?
Style of Guide?
Are Knee Brakes to be furnished?
How many teeth in Cylinder Gear and Jack Gear?
Are Cylinders to be 7" or 8" diameter?
Are Twisters to be 36" or 39" wide?
State distance required between Top of Bobbin and Guide?

Are Twisters to be shipped, knocked down or on feet?
Are Top-Rolls to be grooved?
Are Top-Rolls to be regular $2\frac{1}{8}$ " diam., or Heavy $2\frac{1}{2}$ " diam.?
Are Hank Clocks to be furnished?

Note:—**Band Drive** Frames will be belted at the **Head End** and **Tape Drive** Frames will be belted at the **Foot End** unless otherwise specified.

Please send us a sample **Bobbin** and a sample **Spool**, such as you will use on these Twisters. If these machines are to match present equipment, please send sample **Spindle, Ring, Ring Holder** and **Guide**. We allow 3 Twist Change Gears with each Twister.

EXTRAS.

Wet Twisters, with Single Line Top and Bottom Rolls, add per inch of space.

Tape Drive, 5" Gauge and Below, up to and including $1\frac{1}{4}$ " Tape.

Tape Drive, above 5" Gauge or above $1\frac{1}{4}$ " Tape.

Creels above 4-ply, for each Ply.

Whitin Metallic Thread Boards for Dry Twisters.

Whitin Special Metallic Thread Boards with Porcelain Eye for Wet Twisters.

Knee Brakes for Spindles.

Hank Clocks.

Individual Motor Drive.

Cork Insert Pulleys.

Stop Motions for 2-ply Work.

Separators.

Measuring Knock-off.

Boxing for Knocked-down Shipment.

Extra Twist Gears.

Portable Sewing Machine with Stand.

Spindle Tape.

ALLOWANCES.

For Creels left off.

THE WHITIN PROCESS

Patented Aug. 7, 1917

By this process the waste is taken as it comes from the roving and spinning rooms without any preliminary preparation whatever, and spread in a layer of substantially uniform thickness upon the feed apron of a full roller card. In the passage through the card, the waste is acted on in such a manner as to thoroughly open and untwist the separate pieces without any injury to the fibre or damage to the card clothing. From 16 to 40 ends of the resulting sliver are then run through a Derby Doubler and formed into a lap, two of these laps are fed into the back of a Revolving Flat Card and formed into a sliver. One of these slivers combined with five others made up from the regular work of raw stock is passed through a breaker drawing and thence through a finisher drawing. Thereafter the process proceeds as in the usual course of manufacturing cotton into yarn, the fibre of the waste having been thus restored to its former state of usefulness with but little additional treatment, and without impairing its quality; in fact, it is so thoroughly and evenly mixed with the raw stock as not to be discernable in the resulting product and the shrinkage in weight does not exceed 3%.

Machines for the equipment of one unit of this process are a Full Roller Card, a Derby Doubler and a Revolving Flat Card.

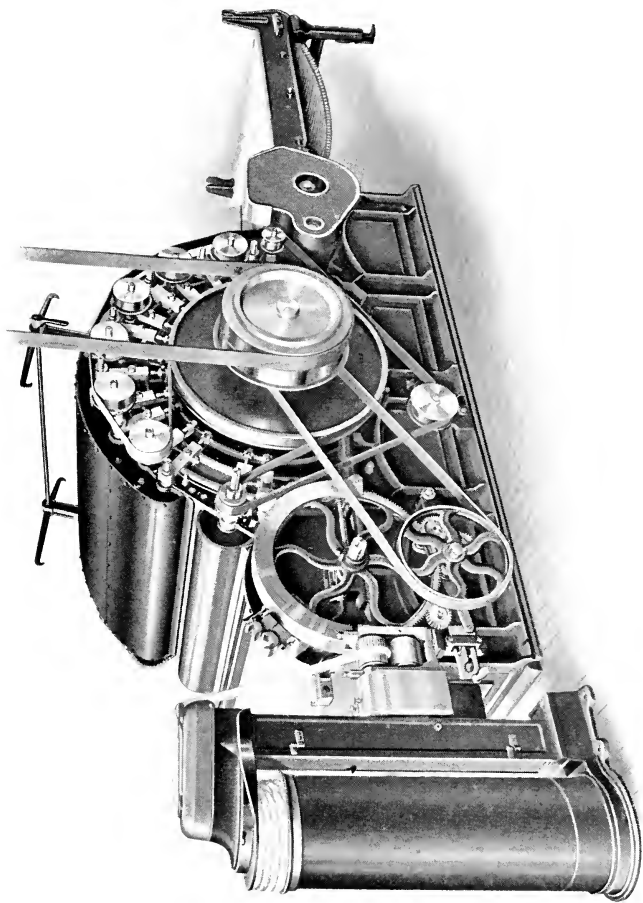

Roving-Waste Card, with Single Coiler

ROVING WASTE CARD

This card is of the full roller type, equipped with metallic breast, workers, strippers and fancy roll. It is usually built with a hand feed apron and a single coiler with belt conveyor front; but, if desired, it may have an automatic feed and double coiler front. If a large production is required, we recommend the double coiler front, for the purpose of making a light sliver rather than running the doffer at a high rate of speed.

Pulleys: 20 inches diam. by 3-inch face.

Speed of Cylinder: 165 r. p. m.

Production: 100 to 200 pounds per day of 10 hours.

Power: About 2 horse power.

Floor Space: 17' 9", by 6' 5".

Weights:

Domestic:

Net, 7750 pounds,
Shipping, 8950 pounds.

Export:

Gross 9500 pounds,
Cubic feet, 475.

Stationary Card Roll Grinder

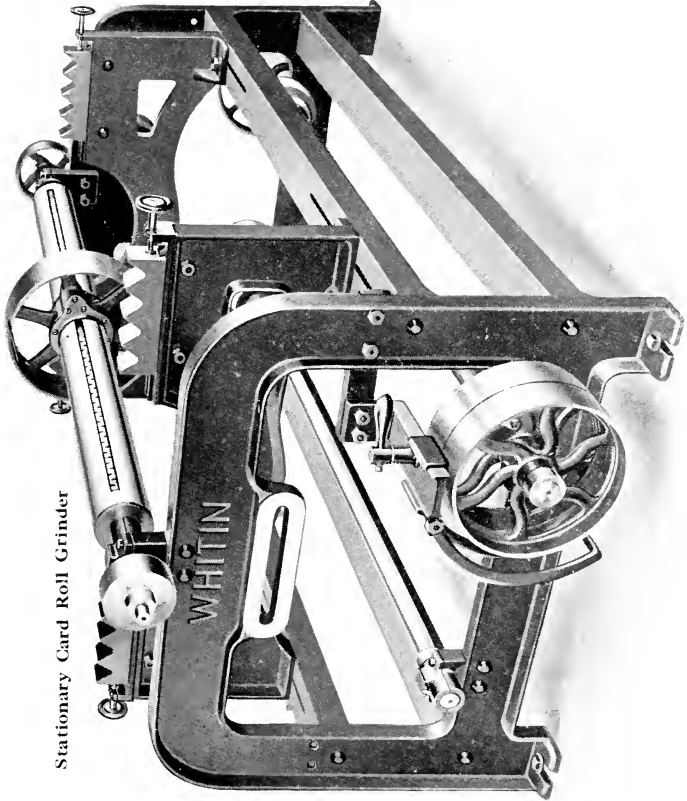

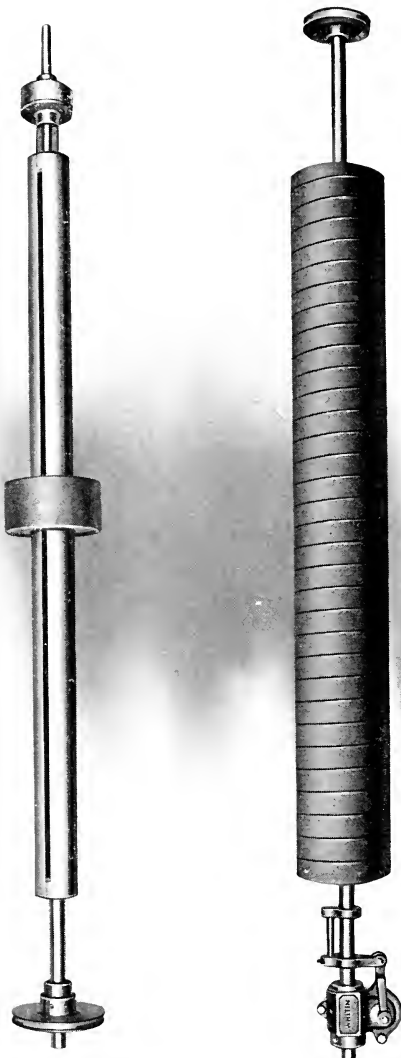

Card Grinding Rolls

CARD GRINDERS

The most essential accessory in the Card Room is a reliable grinding apparatus. Without perfect grinding, the clothing for the Cards, although of the best quality and properly applied, will give unsatisfactory results.

In order that manufacturers may be assured of obtaining the best results, we are prepared to supply grinding apparatus of superior quality for cards from 36" to 61" wide, as illustrated on preceding pages.

The stationary Card Roll Grinder combines all the essential features necessary in the make-up of a perfect grinder. The frame is particularly well adapted to the work it has to do, viz., the grinding of the worker and stripper rolls, it being very heavy and strong and especially designed to resist vibration.

The Traverse Grinder and Long Grinder are designed for both flats and rolls for all widths.

The amount of grinding tackle necessary depends on the number of Cards in operation, but one Stationary Grinder, one or two Traverse Grinders, and one Stripper Roll are necessary where Full Roller Cards are put in for the first time.

Repairs.

We have issued for the convenience of users of our machinery, **Illustrated Circulars of the Component Parts** of each machine which we build. The various pieces are illustrated in a clear manner, numbered and named, so that if the directions for ordering repairs, as stated in circulars, are followed there will be no doubt but what the orders will be correctly filled, with the least possible delay. Copies of these circulars have been sent to all our customers, and extra copies will be sent on application.

The Hands of Machines.

To determine the **Hands** of our **Machines**, face the delivery and note which hand side the driving pulleys are.

Shipping Directions.

We prefer our customers to furnish directions for shipping their orders, but if not given and the package is small, we send by express, if large by freight, selecting the most reliable routes and the lowest freight rates that can be secured.

ESTIMATES

To anyone contemplating textile manufacturing or changes in their present plants, we would be pleased to discuss their requirements, furnish estimates of machinery and costs of new mills or reorganizations of old mills. When making inquiries of this character, give us as full a description as possible of what is desired; the following general particulars are essential:

1. A sample of cotton or fibre to be used.
2. The number of yarn to be spun.
3. Production per day of ten hours.
4. A sketch of Condenser Spool with dimensions.
5. Number of Ends on Spool.

WHITIN MACHINE WORKS

Established 1831

MANUFACTURERS OF THE FOLLOWING MACHINES

COTTON MACHINERY

Opening	Drawing Frames
Conveying	Roving Frames
Distributing	Spinning Frames
Picking	Spoolers
Revolving Flat Cards	Twisters
Sliver Lap Machines	Reels
Ribbon Lap Machines	Quillers
Combing Machines	

COTTON WASTE MACHINERY

Cotton and Woolen Systems

Openers	Revolving Flat Cards
Pickers	Derby Doublers
Willows	Roving Frames
Card Feeds	Spinning Frames
Full Roller Cards	Spoolers
Condensers	Twisters
Special Spinning Frames	

WOOLEN MACHINERY

Cards Feed	Condensers
Full Roller Cards	Wool Spinning Frames

WORSTED MACHINERY

Cone Roving Frames

SUPPLIES

Spindles, Rings, Rolls, Flyers, Saddles and Hank Clocks

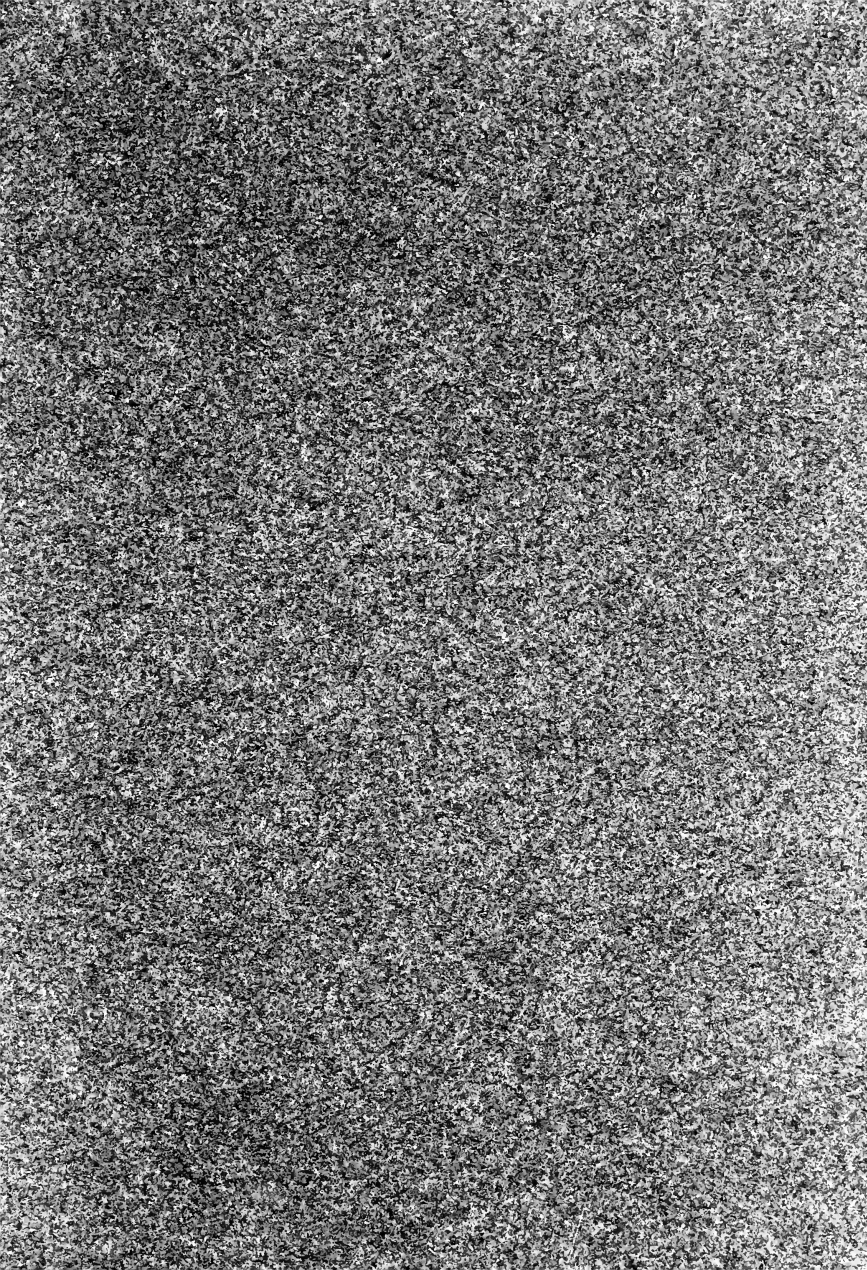

SPECIAL COLL TS 1583 .W58

W37 1919

1919 illustrated and
descriptive catalog of

